

1

2  3  10 

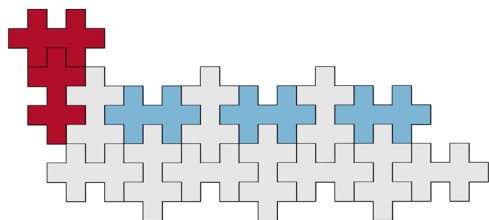

2

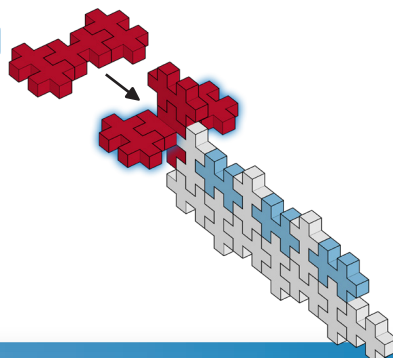

3 

3

11 

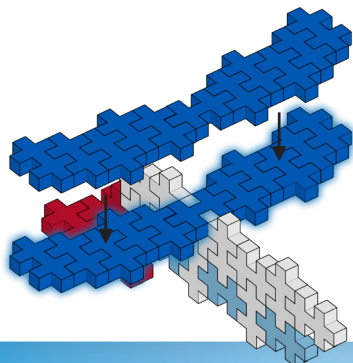

4

2 

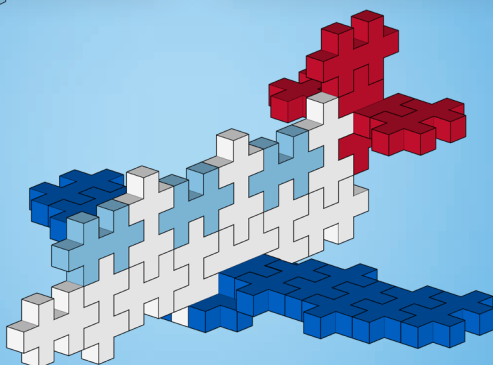
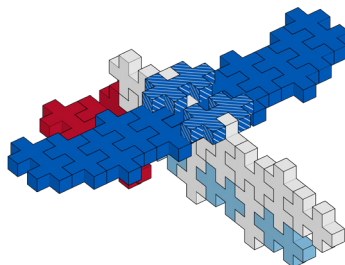

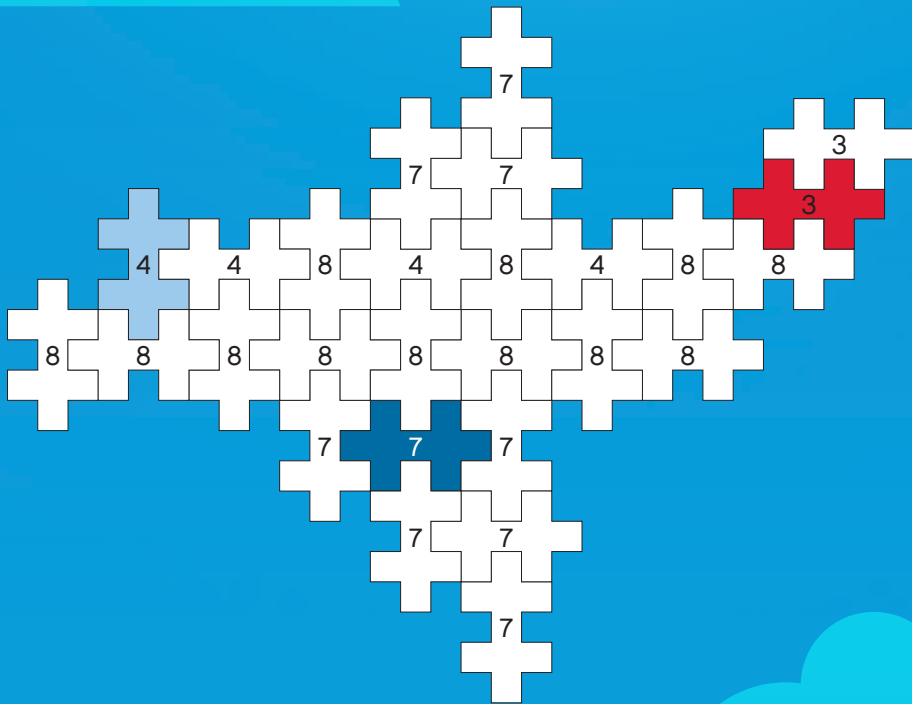

- 1
- 2
- 3
- 4
- 5
- 6
- 7
- 8
- 9
- 10

1



1   
1 

2

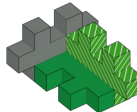

1 

3

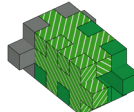

2 

4

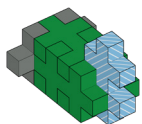

1 

5

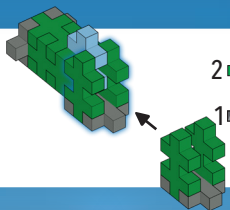

2   
1 

6

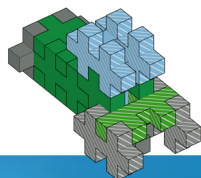



1   
2   
2 

7

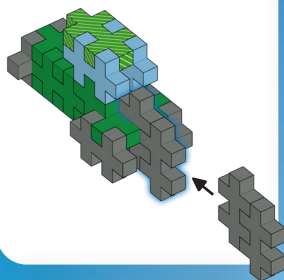
1  2 



8

2  2   
10 

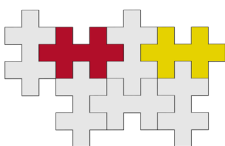

x2

9

4 

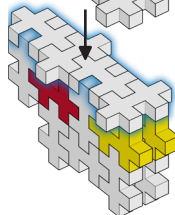

10

2 

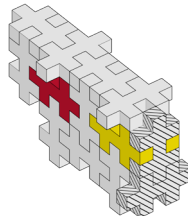

11

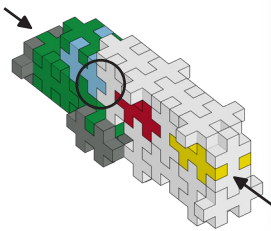

12

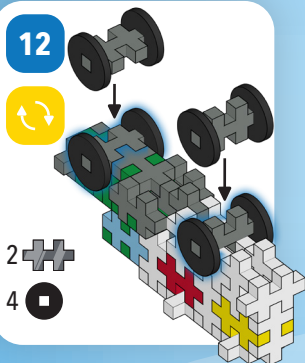

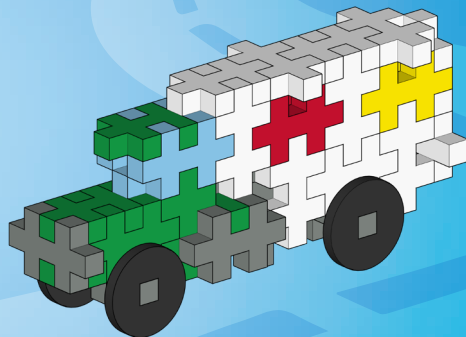

2   
4 

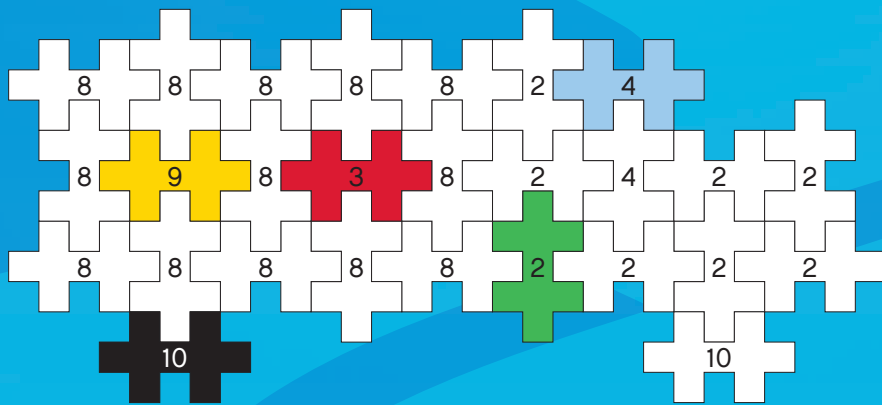



- 1
- 2
- 3
- 4
- 5
- 6
- 7
- 8
- 9
- 10

1

6  10 

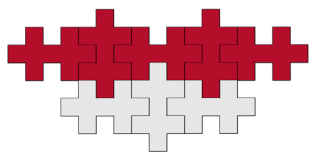

x2

2

3 

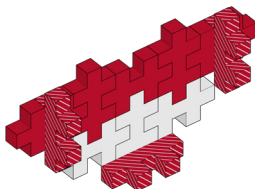

3

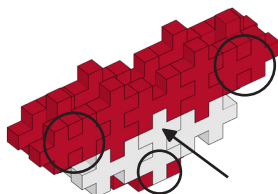

4

4 

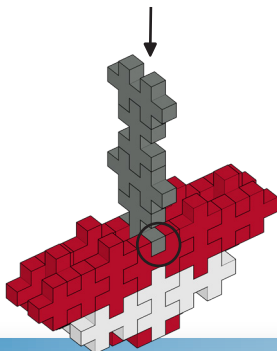
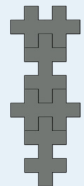

5

1 

2 

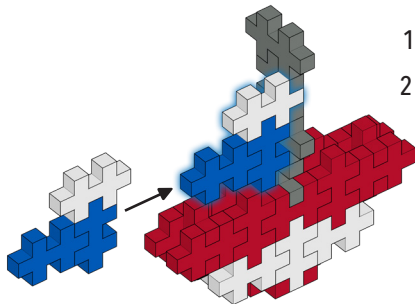

6

2 

4 

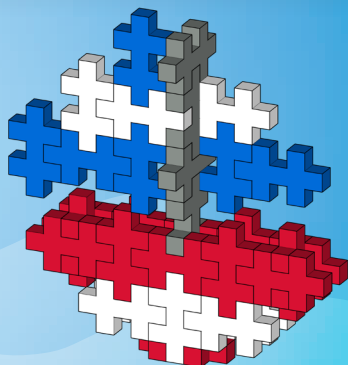
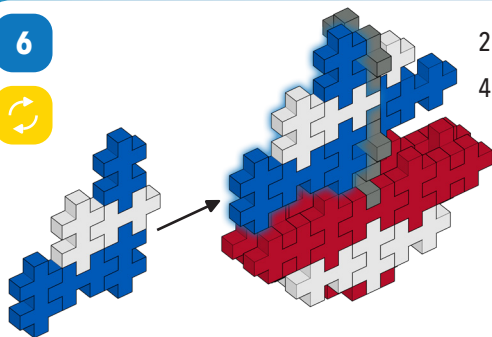

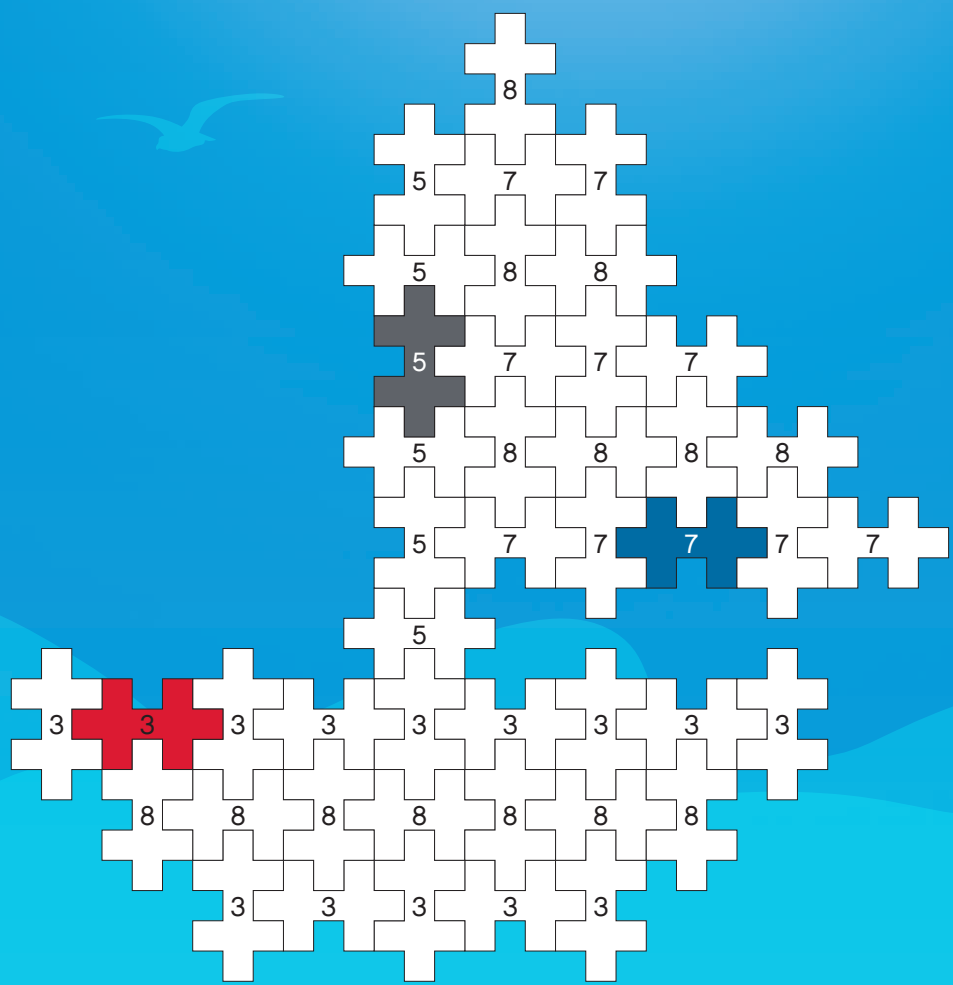

1	
2	
3	
4	
5	
6	
7	
8	
9	
10	

1

4  5  5 

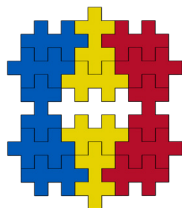

2

6 



x2

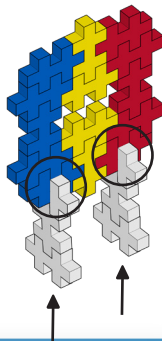

3

3 

3 

3 

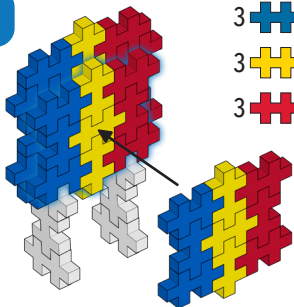

4

5 

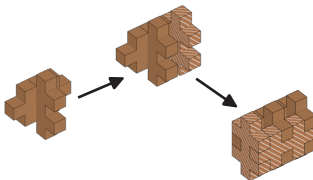

5

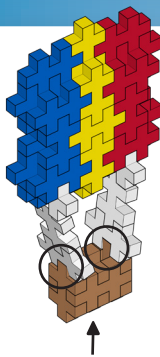

6

1 

1 

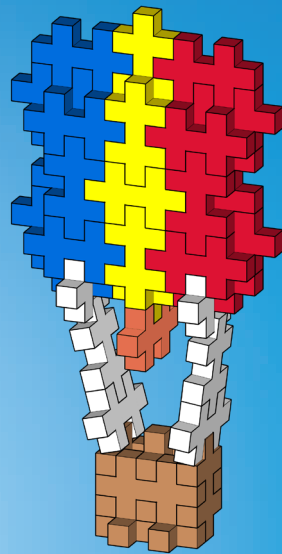
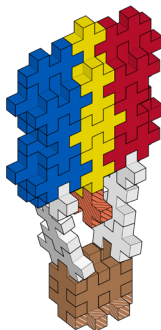

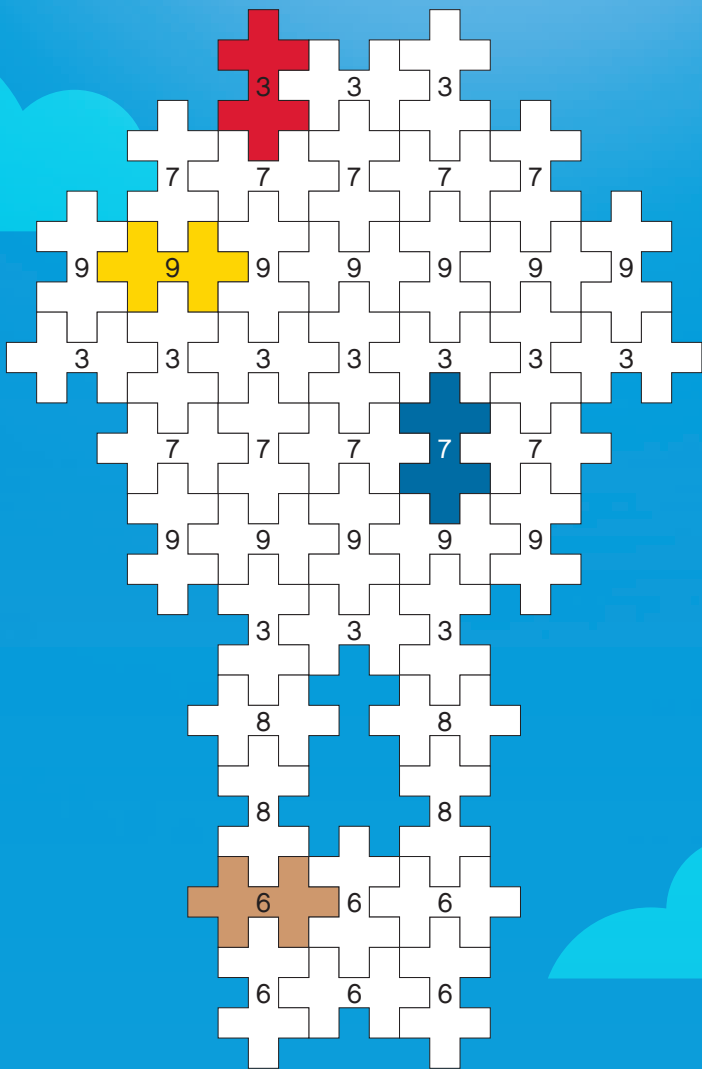

1	
2	
3	
4	
5	
6	
7	
8	
9	
10	



1

8 



x2

2

2 

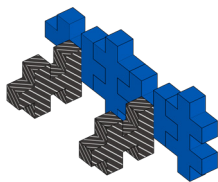

3

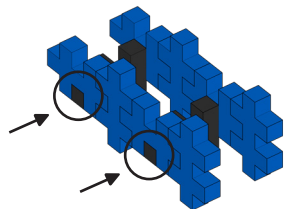

4

1  1 

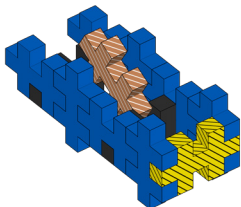

5

1  1 

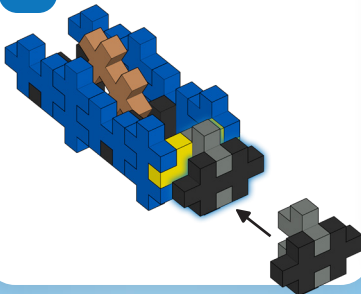

6



4 

4 

x4

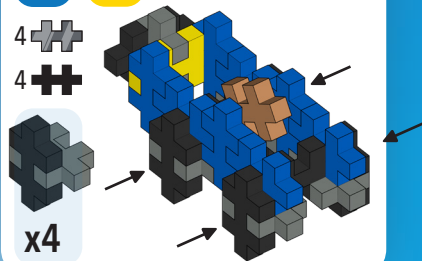

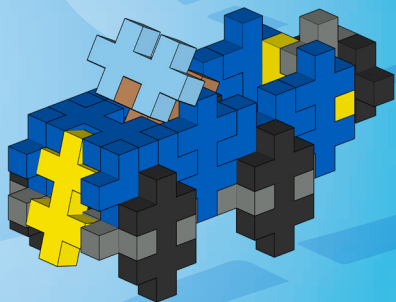
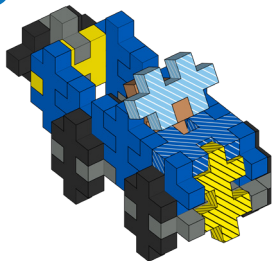

7

1  1  1 





1

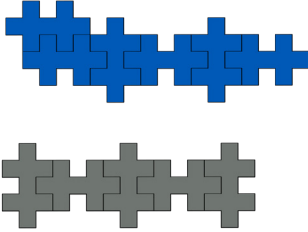

5  6 

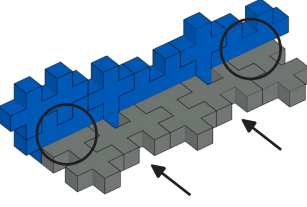

2



3

4   
4 

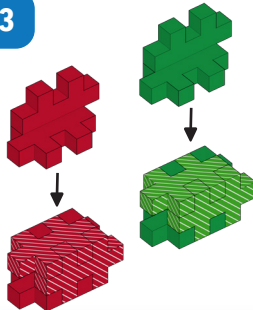

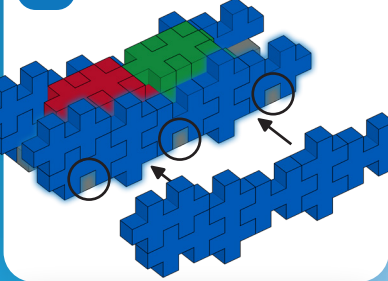

4

6 



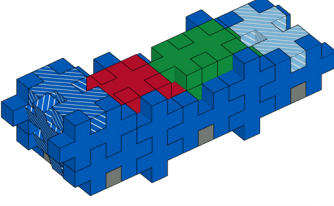

5

1  2 



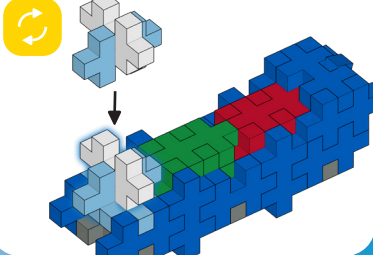

6

1  1 



7

1  2 

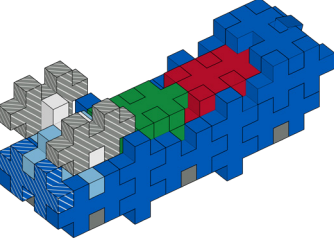

8

1  1 